

Student Instruction Manual

Blender

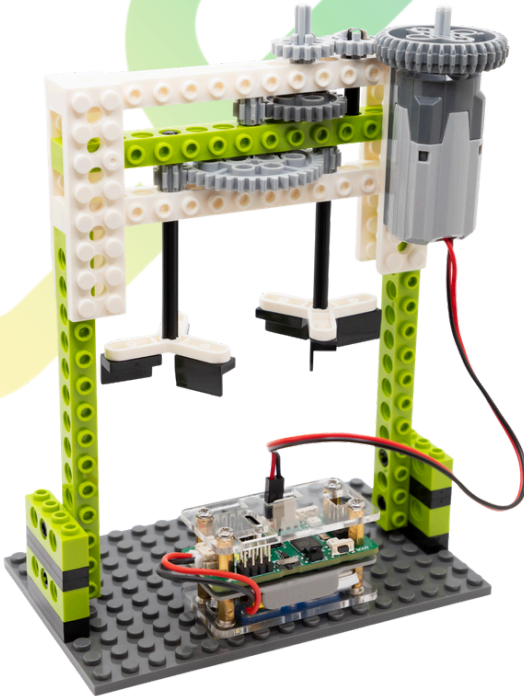

Check for all Blender parts:

4x
3673
Black

2x
10928
Dark Gray

1x
94925
Light Gray



6x
4865
Black

1x
x187
Dark Gray

1x
4019
Light Gray

1x
3649
Light Gray

1x
3705
Black

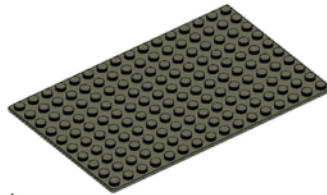

3x
3705
Light Gray

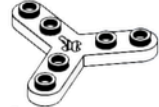

2x
32125
White

8x
3710
Black

1x
bp01
Dark Gray

1x
32498
Light Gray

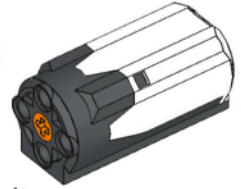

1x
58120c01
White

2x
44294
Black

1x
10928
Light Gray

4x
3034
White

4x
3701
Lime

2x
32018
White

3x
32018
Lime

2x
4265c
Yellow

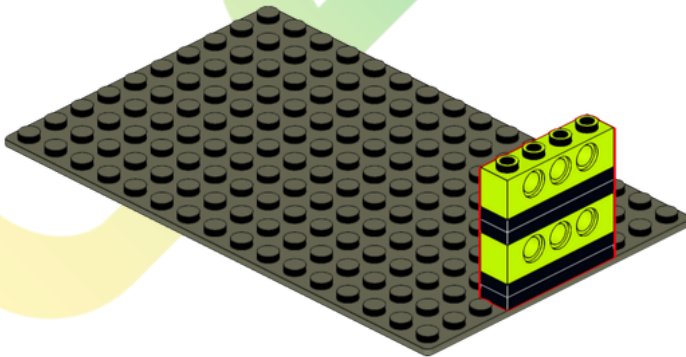
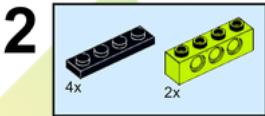
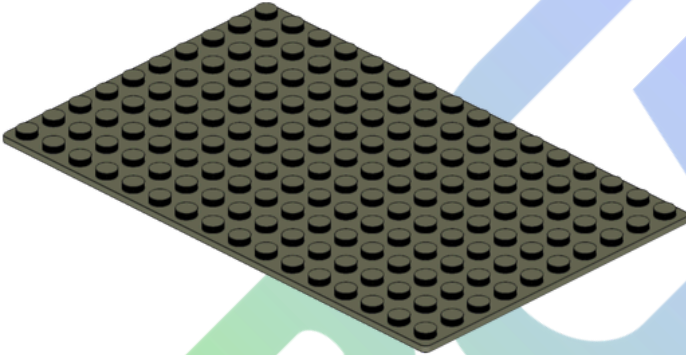
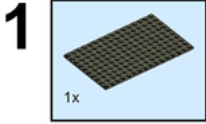

3

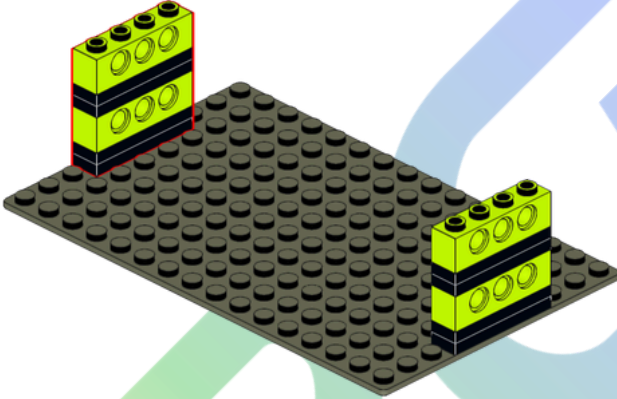
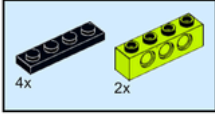

4

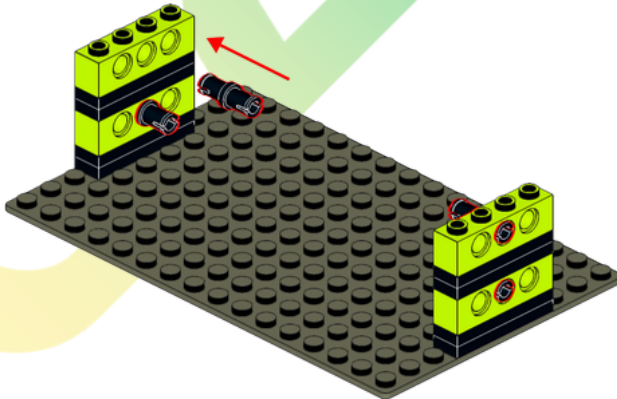

5

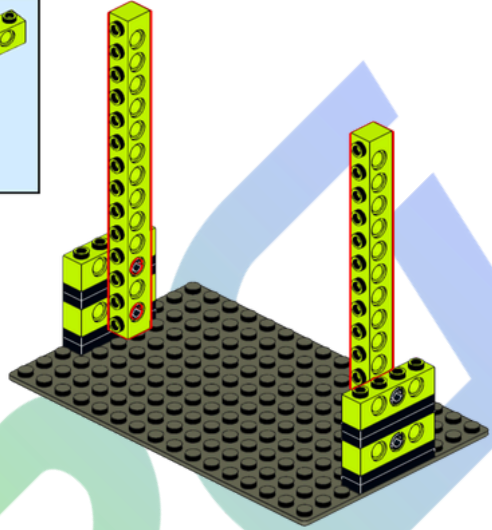
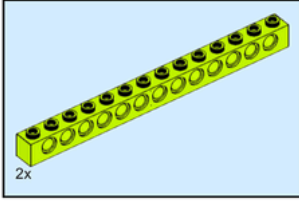

6

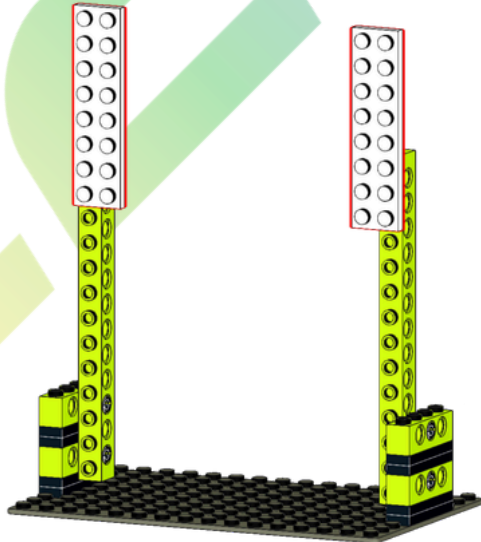
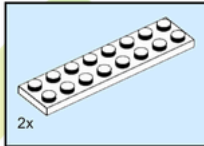

7

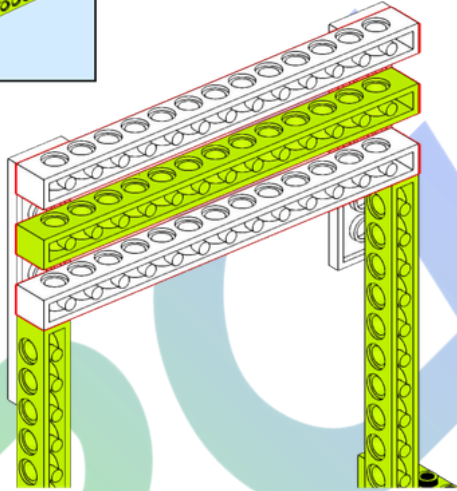
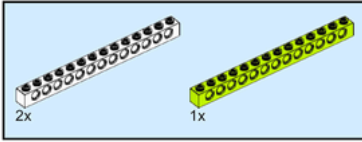

8

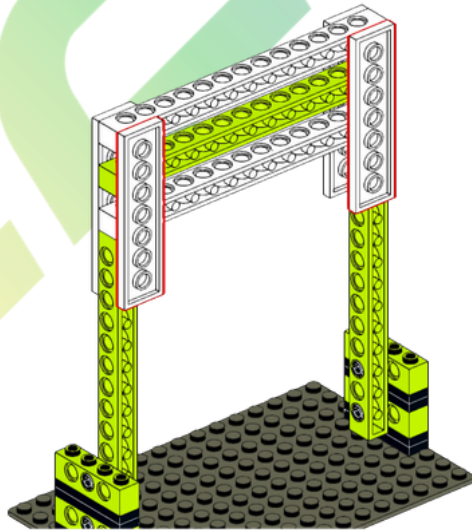
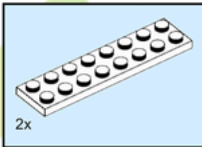

9

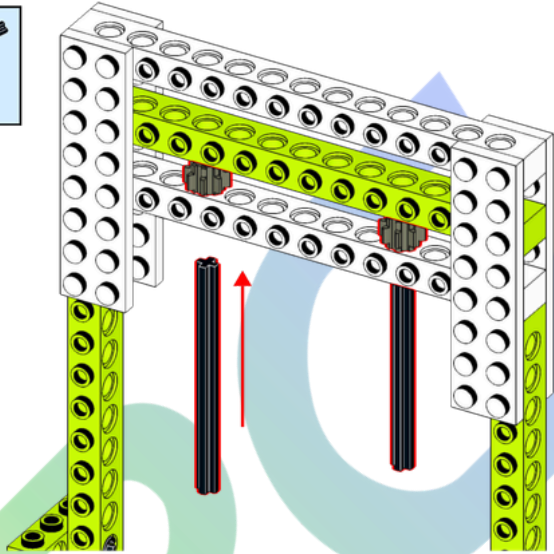
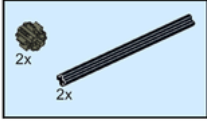

10

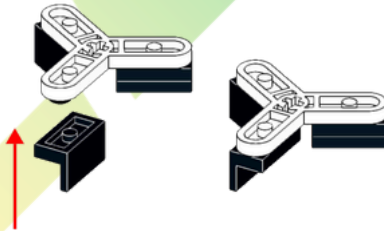
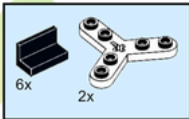

11

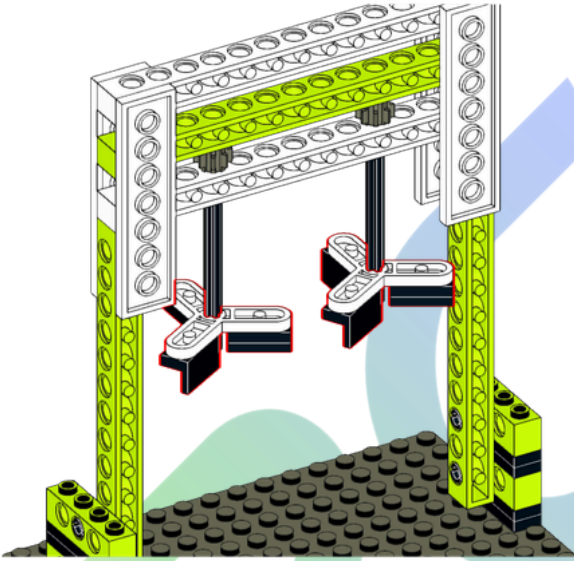

12

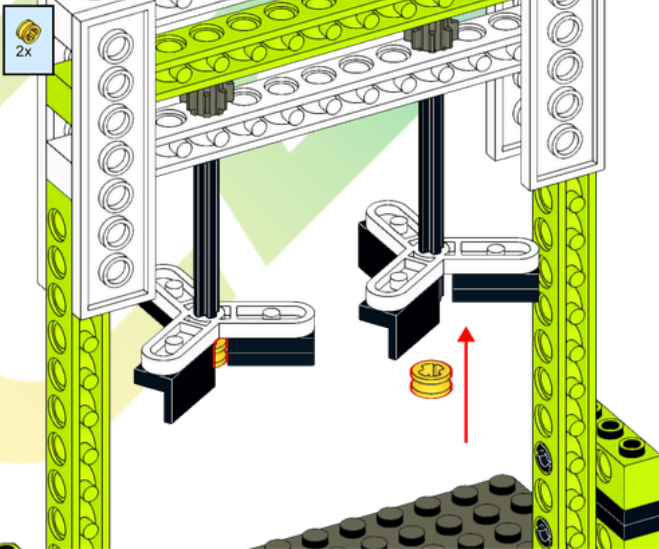

13

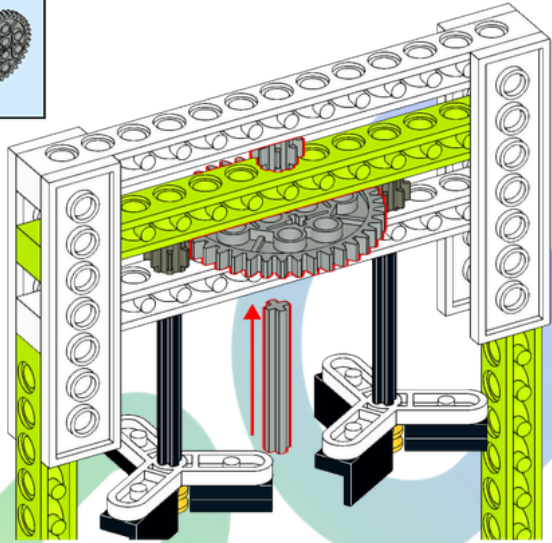
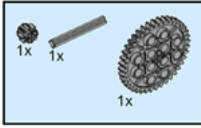

14

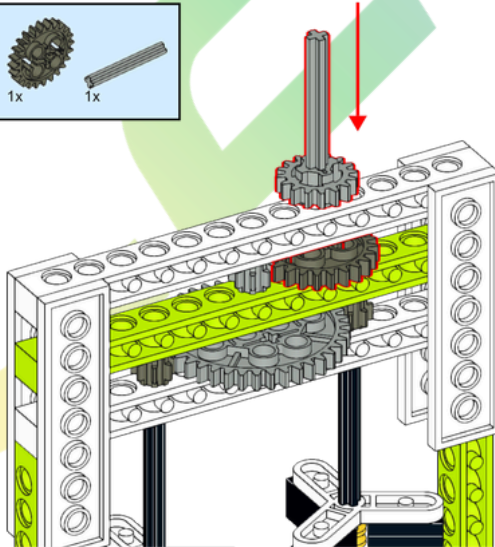
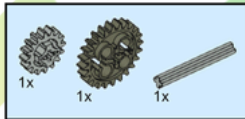

15

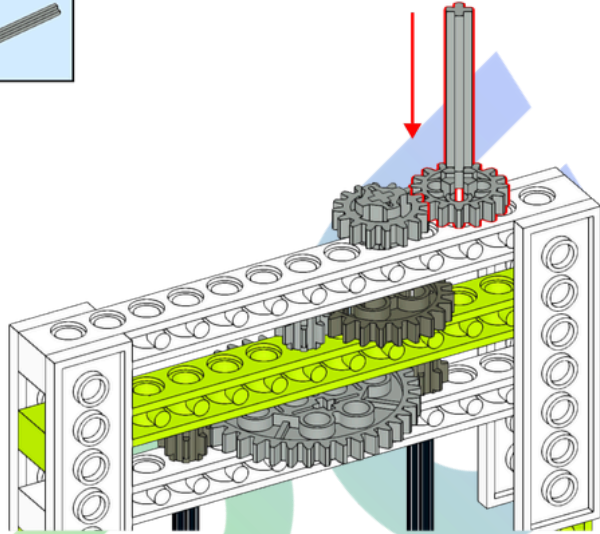
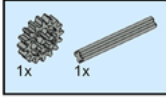

16

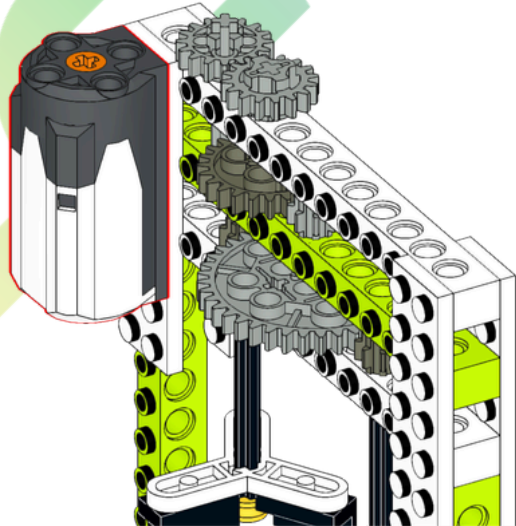
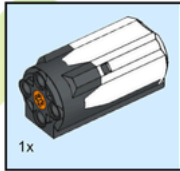

17

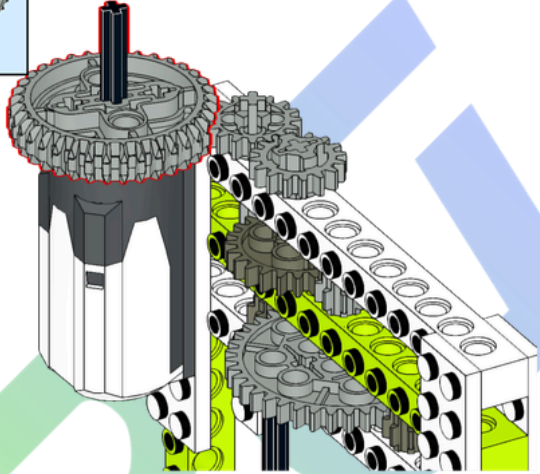
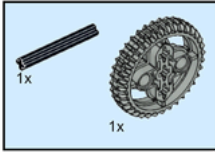

18

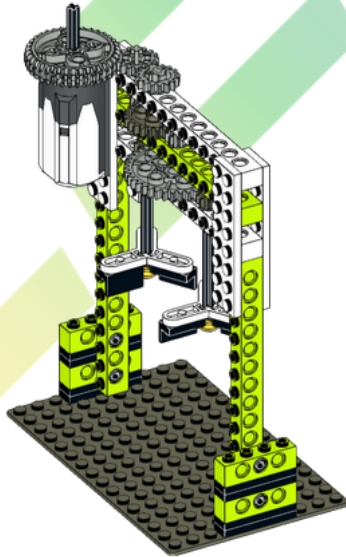

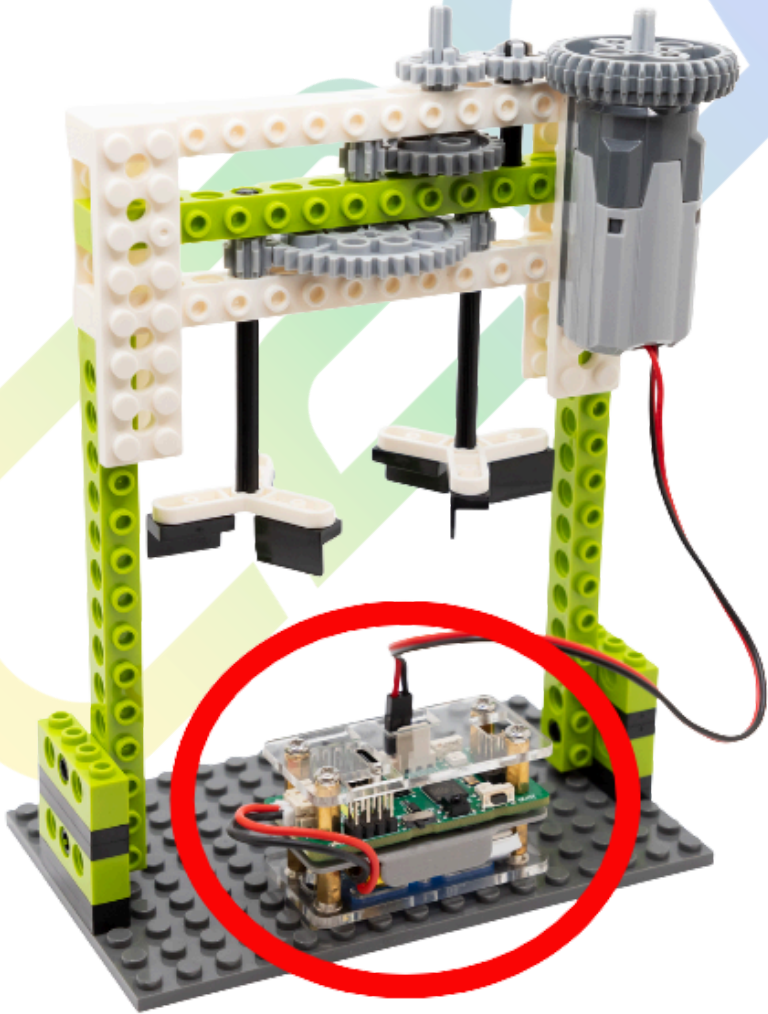

Attach the C2G Mini Microcontroller

How to wire the robot?

C2G Mini Wiring Schematics

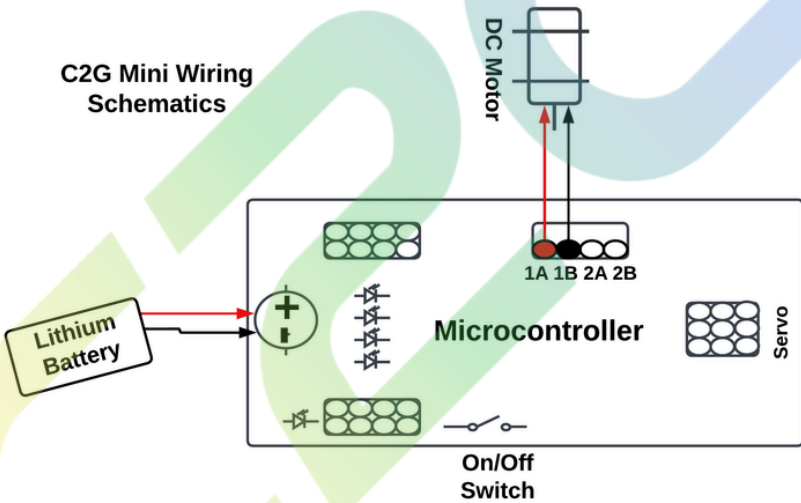

1A: Red wire of DC motor
 1B: Black wire of DC motor

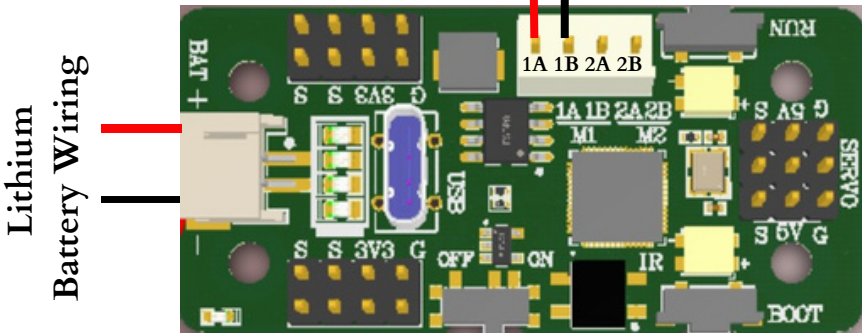

Congratulations on
completing the
Blender build!

